



NEW MAINTENANCE

CONCEPT FOR

TAPERED GRID COUPLINGS



VARIOUS BENEFITS



EASY & FAST



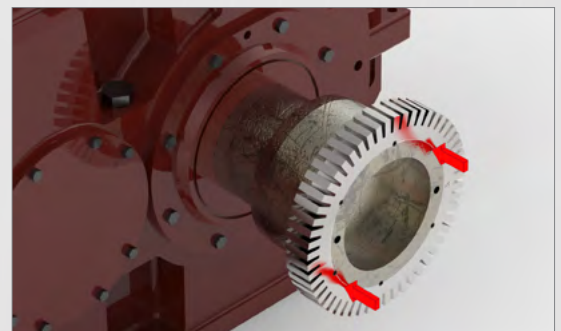
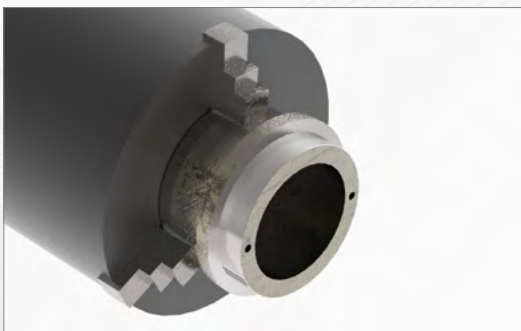
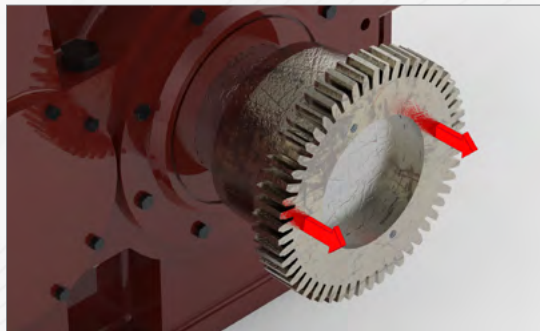

PROCESS >>



NEW MAINTENANCE CONCEPT FOR TAPERED GRID COUPLINGS

COUPLINGS EXCHANGE LIST



SIZES	DESIGNED TO FIT			
				
KIT DG 15	15 DG	2150H	1150T	1150T10
KIT DG 16	16 DG	2160H	1160T	1160T10
KIT DG 17	17 DG	2170H	1170T	1170T10
KIT DG 18	18 DG	2180H	1180T	1180T10
KIT DG 19	19 DG	2190H	1190T	1190T10
KIT DG 20	20 DG	2200H	1200T	1200T10

SERVICE EXPERIENCE: Well known solution with Flexacier



OTHER COUPLINGS according to French steel industry standard (S45604-A)

Flexident Senior

Flexident Z



CONTACT: couplings@cmdgears.com www.cmd-couplings.com

